



DÉFILÉ
MOTORISÉ
VERSION DÉFINITIVE
15/05/2013

armée

général

—

jeune



DÉFILÉ DU 14 JUILLET 2013

MAQ 11 - P 03

CAB.GMP/PCM
V 15/05/2013

DÉFILÉ MOTORISÉ

GENDARMERIE
NATIONALE



POLICE NATIONALE



CENTRE NATIONALE DE FORMATION À LA SÉCURITÉ ROUTIÈRE

CRS

PRÉFECTURE DE POLICE

DIRECTION CENTRALE DE LA SÉCURITÉ PUBLIQUE

MOTOS

82

82

ÉTAT-MAJOR EMF 3

VBLL

6

COM 9^{ème} BIMA + EM (+ EM Réserve)

9^{ème} BIMA

VBLL - VBL

6 (+4)

EAE [RICM]

9^{ème} BIMA

VBL 12,7 - VBL MILAN - VAB T20 - VAB HOT

17

BRB 9

9^{ème} BIMA

PVP - VAB

9

3^{ème} RIMa

9^{ème} BIMA

VAB - VBCI

22

RICM

9^{ème} BIMA

X10RC - ERC 90 SAGAIE

27

11^{ème} RAMa

9^{ème} BIMA

VAB Mo 120 - CAESAR

16

6^{ème} RG

9^{ème} BIMA

MINOTAUR - MATS - GRUE LIEBHERR

14

54^{ème} RT

B RENS

SPÉCIFIQUE RGE

9

TERRE



130

AIR



EDSA 12.950 TURSAN

SPÉCIFIQUE

17

17

INTERARMÉES



BPIA

SPÉCIFIQUE

13

13

SECOURS



AUX POPULATIONS

BSPP

SPÉCIFIQUE

23

23

TOTAL VÉHICULES

=

265



DÉFILÉ DU 14 JUILLET 2013

ARTICULATION MOTOCYCLISTES

DM 01 - V 02

CAB.GMP/PCM

V 15/05/2013

CDTs D'ESCADRON

ESCADRON MOTOCYCLISTE
DU CENTRE NATIONAL DE FORMATION
À LA SÉCURITÉ ROUTIÈRE



10 RANGS
DE
4 MOTOCYCLISTES

ESCADRON MOTOCYCLISTE
DE LA POLICE NATIONALE



10 RANGS
DE
4 MOTOCYCLISTES

Place de la Concorde



Place de l'Étoile

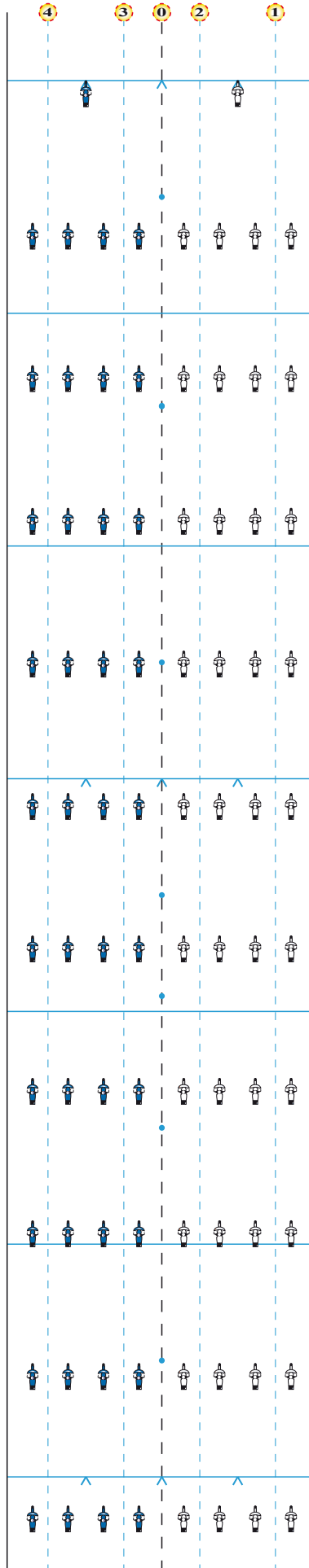

TOTAL : 82



DÉFILÉ DU 14 JUILLET 2013

ARTICULATION EMF 3

DM 02 - V 01

CAB. GMP/PCM

V 15/05/2013

VLRA COM EMF

VBL CEM

VBL

4 3 0 2 1

VL GUIDE
(à la charge de l'unité)



Place de la Concorde



Place de l'Étoile

TOTAL : 6



DÉFILÉ DU 14 JUILLET 2013

ARTICULATION COM 9 BIMa

DM 03 - V 02

CAB. GMP/PCM

V 15/05/2013

VBL COM 9 BLBMa

VBL CEM

VBL

VBL

4 3 0 2 1

VL GUIDE
(à la charge de l'unité)



Place de la Concorde



Place de l'Étoile

RÉSERVISTES

TOTAL : 6 + 4



DÉFILÉ DU 14 JUILLET 2013

ARTICULATION EAE [RICM]

DM 04 - V 02

CAB. GMP/PCM

V 15/05/2013

VBL CDT D'UNITÉ

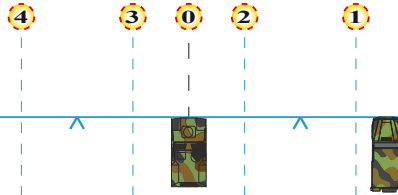

VL GUIDE
(à la charge de l'unité)

VBL

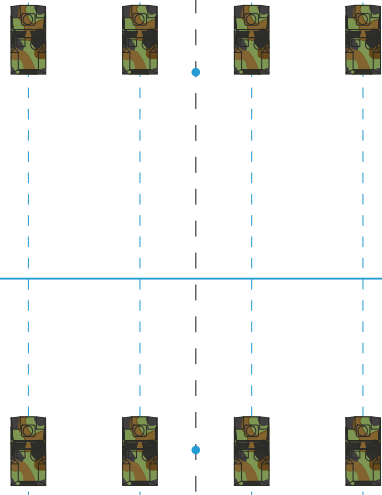

VBL 12.7 - VBL MILAN

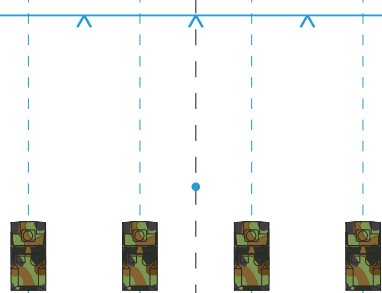

VAB T20 - VAB HOT

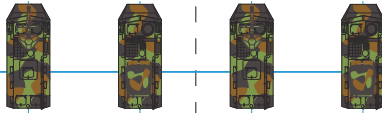

Place de la Concorde



Place de l'Étoile

TOTAL : 17



DÉFILÉ DU 14 JUILLET 2013

ARTICULATION BRB 9

DM 05 - V 01

CAB. GMP/PCM

V 15/05/2013

VAB PC CDT D'UNITÉ

PVP

VAB PC

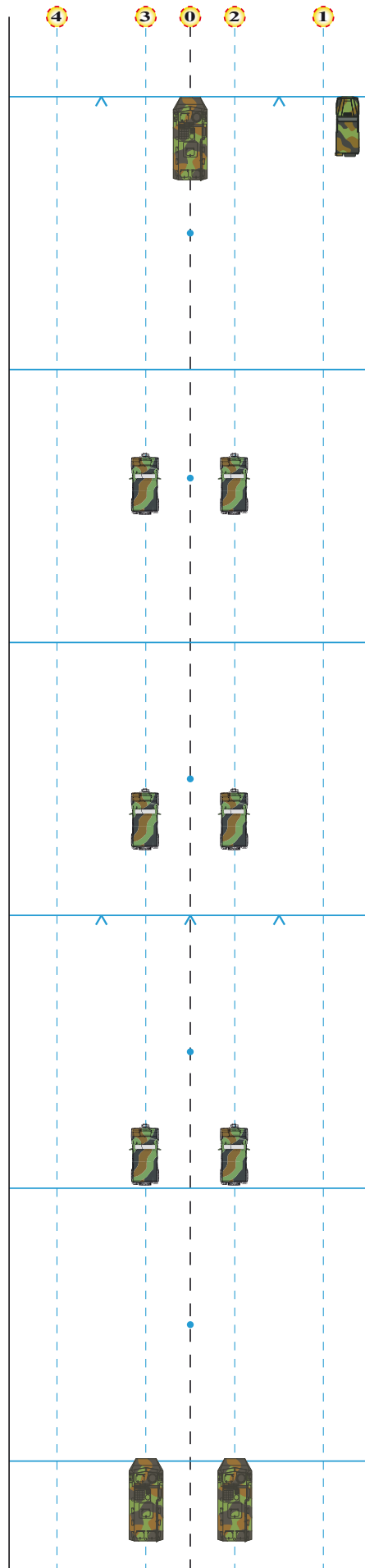

← VL GUIDE
(à la charge de l'unité)



Place de la Concorde



Place de l'Étoile

TOTAL : 9



DÉFILÉ DU 14 JUILLET 2013

ARTICULATION 3 RIMa

DM 06 - V 02

CAB.GMP/PCM

V 15/05/2013

VBLL CHEF DE CORPS

VBLL EMBLÈME

VAB PC CDT D'UNITÉ

VAB INF

VBCI

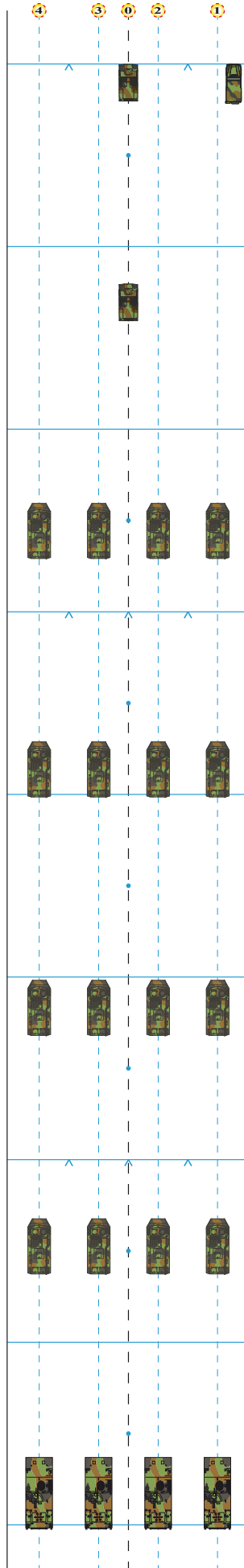

← VL GUIDE
(à la charge de l'unité)



Place de la Concorde



Place de l'Étoile

TOTAL : 22



DÉFILÉ DU 14 JUILLET 2013

ARTICULATION RICM

DM 07 - V 02

CAB.GMP/PCM

V 15/05/2013

VBL CHEF DE CORPS

VBL EMBLÈME

VAB PC

AMX 10 RC

VBL

AMX 10 RC

VBL

ERC 90 SAGAIE

VBL

ERC 90 SAGAIE

VBL

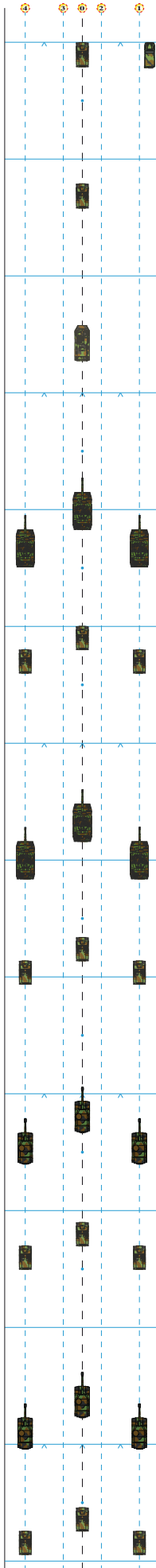

VL GUIDE
(à la charge de l'unité)



Place de la Concorde



Place de l'Étoile

TOTAL : 27



DÉFILÉ DU 14 JUILLET 2013

ARTICULATION 11 RAMa

DM 08 - V 01

CAB. GMP/PCM

V 15/05/2013

VAB PC CHEF DE CORPS

VAB PC EMBLÈME

VAB ATLAS CDT D'UNITÉ

PVP

VAB MORTIER + MO 120

CAESAR

CAESAR

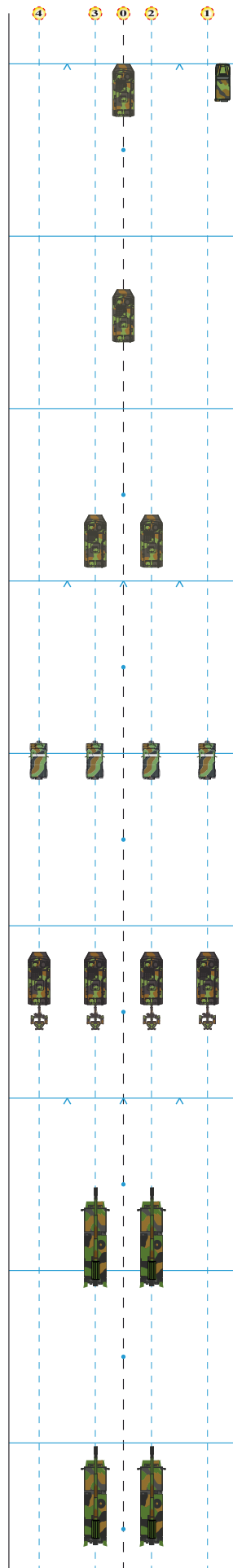

VL GUIDE
(à la charge de l'unité)



Place de la Concorde



Place de l'Étoile

TOTAL : 16



DÉFILÉ DU 14 JUILLET 2013

ARTICULATION 6 RG

DM 09 - V 02

CAB. GMP/PCM

V 15/05/2013

VAB PC CHEF DE CORPS

VAB PC EMBLÈME

VAB GEN

MINOTAUR - MATS

SCANIA + RQ ACTM + EGAME

GRUE LIEBHERR

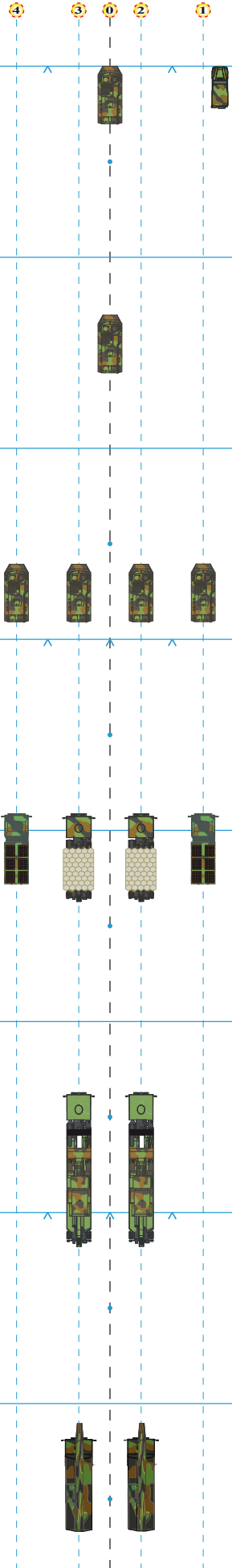

← VL GUIDE
(à la charge de l'unité)



Place de la Concorde



Place de l'Étoile

TOTAL : 14



DÉFILÉ DU 14 JUILLET 2013

ARTICULATION 54 RT

DM 10 - V 03

CAB. GMP/PCM

V 15/05/2013

P4 CHEF DE CORPS

P4 EMBLÈME

P4 CDT D'UNITÉ

PVP GE

VAB COGE

VAB SAEC

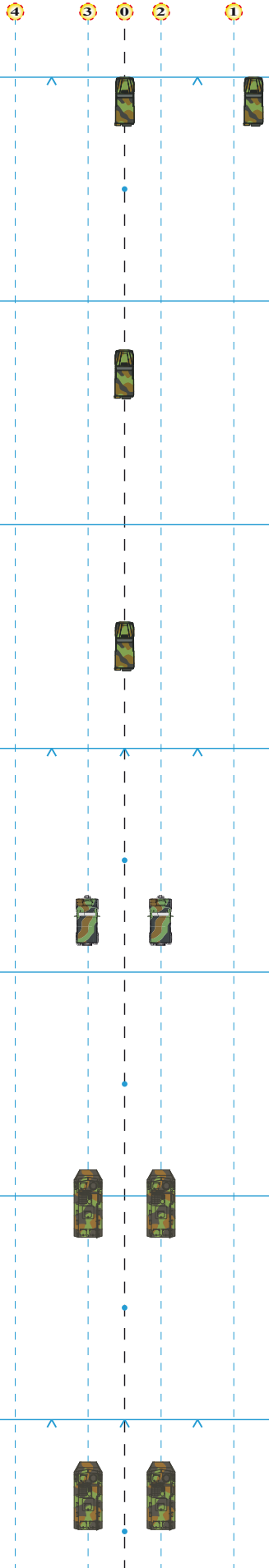

← VL GUIDE
(à la charge de l'unité)



Place de la Concorde



Place de l'Étoile

TOTAL : 9



DÉFILÉ DU 14 JUILLET 2013

ARTICULATION EDSA 12.950 TURSAN

DM 11 - V 01

CAB. GMP/PCM

V 15/05/2013

P4 CDT D'UNITÉ

P4 EMBLÈME

DEFENDER
(RECONNAISSANCE)

ME - MRI - MGE
(CONDUITE DE TIR)

MLT
(LANCEURS ASTER 30)

MRT
(RECHARGEMENT ASTER 30)

SAM - SAE
(SOUTIEN TECHNIQUE)

CROTALE NG

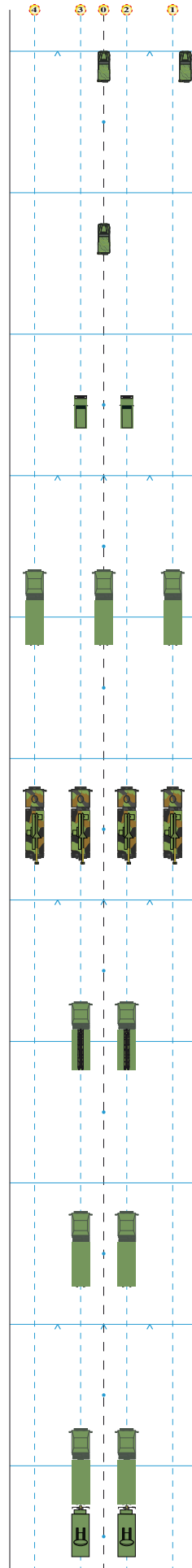

VL GUIDE
(à la charge de l'unité)



Place de la Concorde



Place de l'Étoile

TOTAL : 17



DÉFILÉ DU 14 JUILLET 2013

DM 12 - V 02

CAB. GMP/PCM

V 15/05/2013

ARTICULATION BPIA

P4 CHEF DE CORPS

P4 EMBLÈME

P4 CDT D'UNITÉ

CAMION DE L'AVANT + RQ

G 430 BLINDÉS + RQ

TOE + RQ

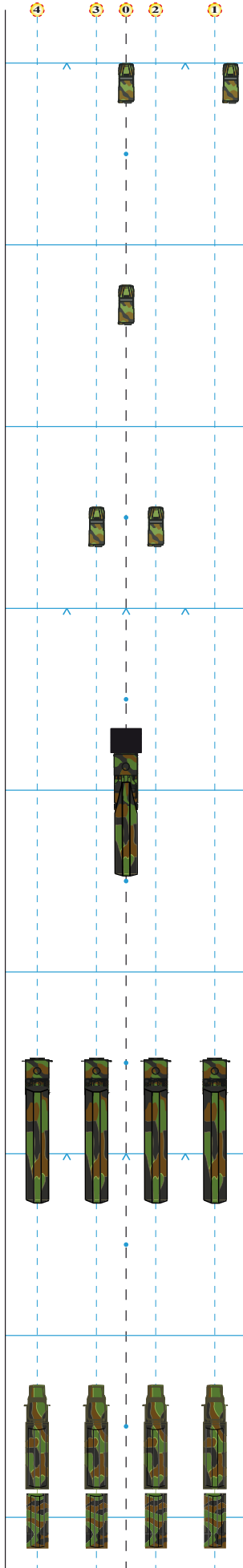

← VL GUIDE
(à la charge de l'unité)



Place de la Concorde



Place de l'Étoile

TOTAL : 13



DÉFILÉ DU 14 JUILLET 2013

ARTICULATION BSPP

DM 13 - V 01

CAB. GMP/PCM

V 15/05/2013

VLRA COM BSPP

PST

SPVL

VSAV - AR

VIGI - VPS

CCR - FPT

EPA - BEA

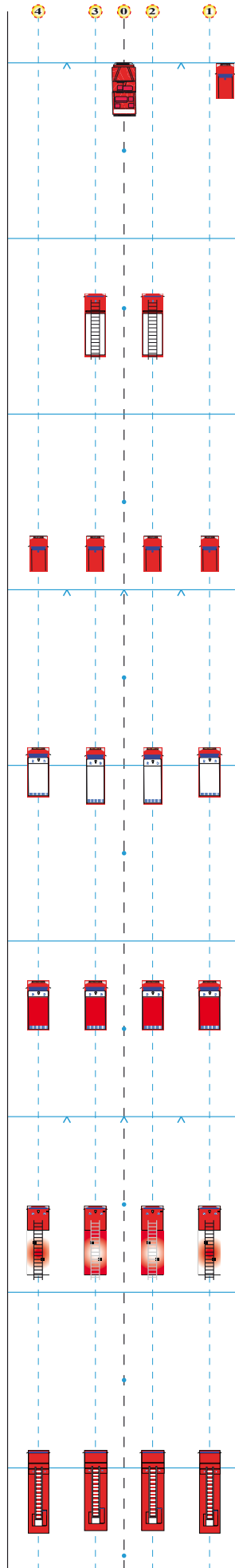

VL GUIDE
(à la charge de l'unité)



Place de la Concorde



Place de l'Étoile

TOTAL : 23